

FIMET

THE ART OF MEDICAL DESIGN

NEO Ceiling



FIMET

NEO Ceiling

The Neo Ceiling Dental Unit - Get ready to experience a workspace that combines modern innovation with practical efficiency—perfect for clinics of all sizes.



This brochure includes some optional features that are available for an additional cost.



WHY CEILING-MOUNTED MAKES SENSE

Imagine a dental unit that not only saves space but transforms your entire clinic into a sleek, efficient, and welcoming environment.

The Neo Ceiling Dental Treatment Unit does just that, combining cutting-edge design with practical innovation to enhance every aspect of your practice.

Forget costly floor renovations with ceiling mounted installation

Durable materials ensure a long lifespan for the device.

Manage everything from intuitive touchscreen

Change instrument bridge according to your preferences with Plug-In instrument hoses

Choose between comFORT, XtraSOFT & UltraLUX cushions

The 90° rotation allows adaptation to different situations.

Compact base allows installations to smaller rooms.

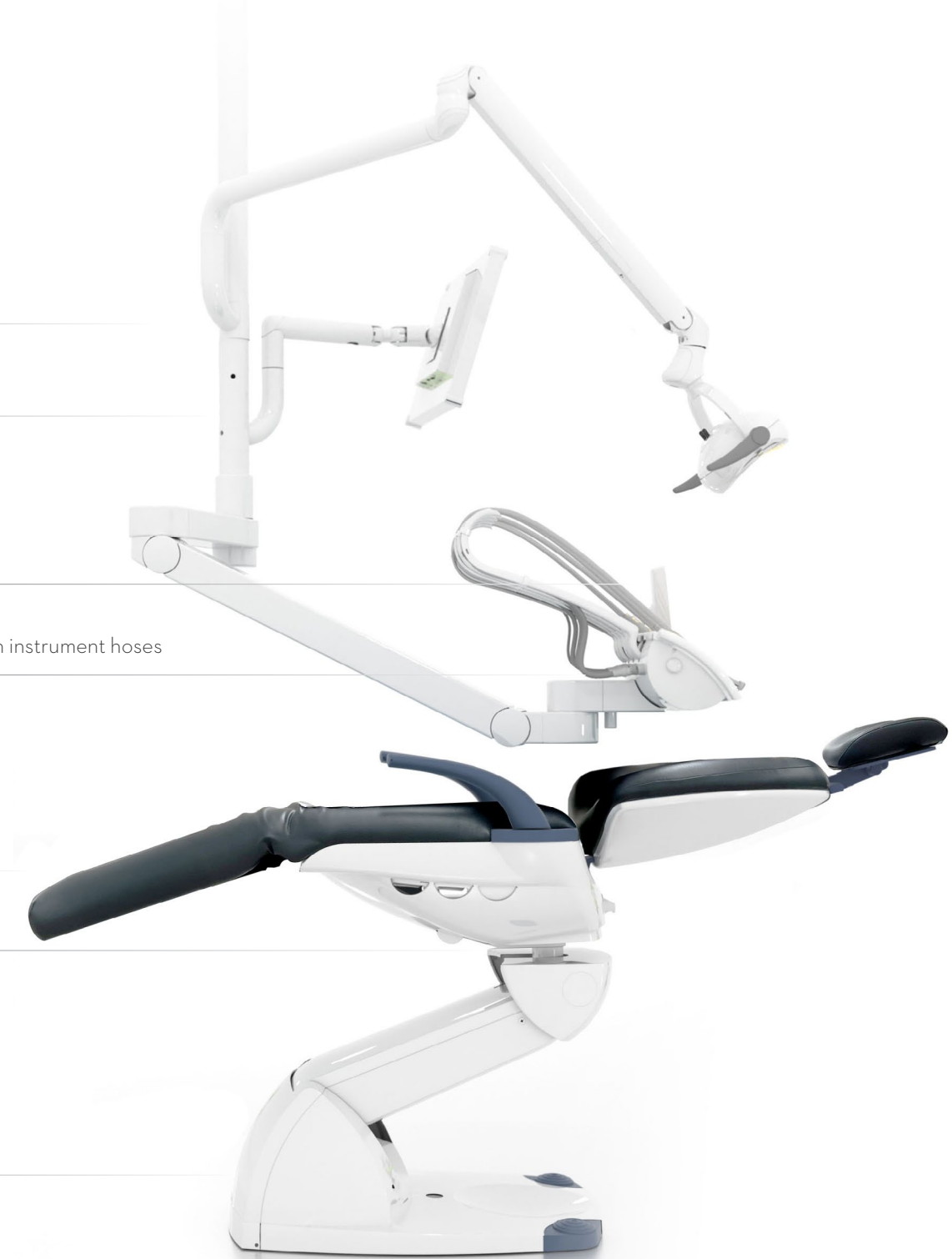

SAVE SPACE, SAVE COSTS

Compact and Clever

Designed for small rooms, this unit maximizes every square meter while keeping the space open and comfortable. You can also forget costly renovations—utilities like air, water, and electricity are routed neatly through the ceiling.

Discreet, slim conduits house all your utilities, keeping the workspace clean and organized.



FUTURE-PROOF YOUR PRACTICE

Whether you're expanding, relocating, or just upgrading, the modular design ensures the Neo Ceiling unit can move and grow with you. It's an investment that evolves with your needs.

Forget costly renovations—utilities like air, water, and electricity are routed neatly through the ceiling.

Made for the Long Haul

Durability is at the heart of the Neo Ceiling unit. With sturdy metal arms and premium materials, it resists wear and tear, staying as sleek and functional as the day it was installed.

HYGIENE WITHOUT HASSLE

Clean and timeless Nordic design is at the heart of our approach. The NEO Ceiling is not just visually appealing—its smooth surfaces, with minimal seams and gaps, make daily cleaning and maintenance effortless.

This leaves you and your team more time to focus on your patients. Durable, long-lasting materials are carefully selected to withstand wear and the most commonly used cleaning agents.



Optimized Disinfection Saves Time

Neo Ceiling is designed to streamline hygiene routines, reducing time spent on non-billable tasks like water and suction line disinfection. This ensures a faster workflow without compromising patient safety or care quality, enhancing overall efficiency.

Smart Automation for Seamless Workflow

Equipped with advanced automated disinfection systems, Neo Ceiling minimizes manual steps. With features like automatic suction line cleaning and easy disinfectant replacement, it allows smooth patient transitions while keeping hygiene effortless.

Long-Term Reliability & Safety

Consistent and thorough disinfection not only maintains patient safety but also extends the lifespan of essential equipment. By preventing buildup and blockages, Neo Ceiling reduces maintenance needs and ensures uninterrupted performance.

INNOVATION AT EVERY ANGLE

Features You'll Love



TECHNOLOGY THAT FITS YOUR

Streamline Your Day

The touchscreen reshapes the way you use Fimet products. It has been designed to streamline your daily work with its intuitive, clear and easy to use user interface. User specific adjustments ensure that the unit feels like its tailored just for you.

Manage everything—chair adjustments, lighting, and instruments—through the intuitive touchscreen.

The simple, clear design ensures your team spends less time fumbling with controls and more time focusing on what really matters—your patients.

Integrated NSK Varios 170 scaler presets

Tip settings and images of the tips are preloaded into the interface as presets. By entering the name of the tip, the standard NSK factory setting is automatically applied.

If more power is needed, the output can be manually increased. The interface also allows the user to save up to four tips in a quick-access menu, making tip selection fast and easy.

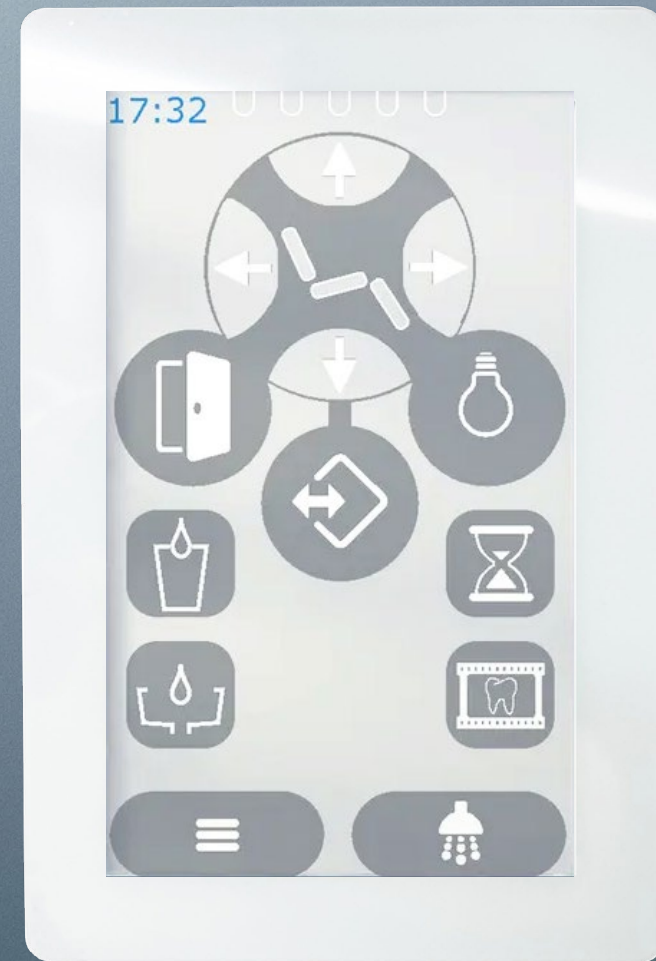

Save up to four different chair presets to boost your working ergonomics. When using pre-customized positions, your working position is best possible for you, every time.

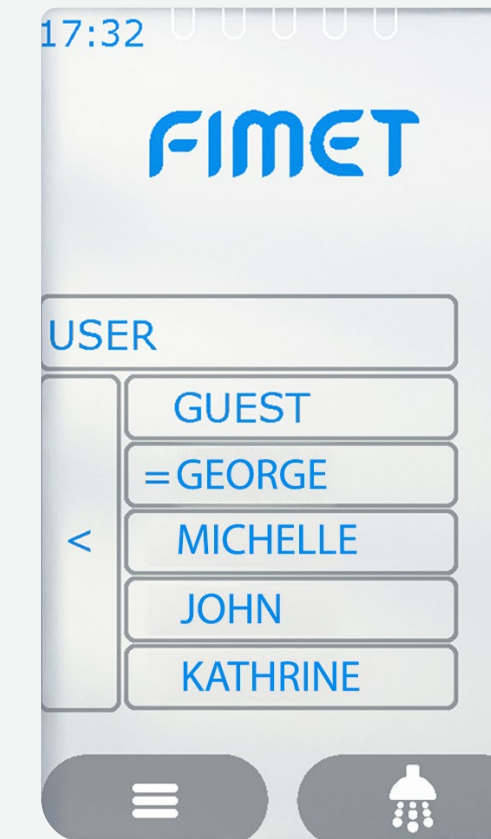

Create and save custom settings for each staff member, from chair positions to instrument preferences. It's like having your clinic tailored to you every time.

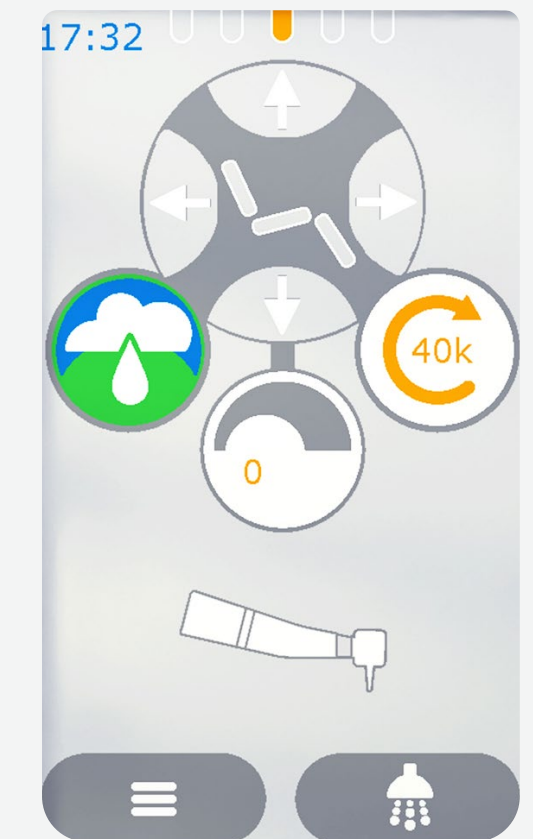

Highly intuitive and easy to use instrument controls, designed for accessibility. Clear indicators in vibrant colors guide your work.

ERGONOMICS THAT WORK FOR YOU

Smooth Chair Rotation and Inclusive Design

The chair rotates 45° to both sides, allowing the workspace to adapt to different situations. With more working room around the chair, accommodating wheelchair users and other patients with mobility challenges becomes effortless.



VERSATILITY WHEN YOU NEED IT MOST

Flexible Tools

Quickly adapt between 2-handed and 4-handed procedures. No stress, no delay—just seamless transitions.

As the instrument console and the tray holder are placed over the patient's chest, real four-handed dentistry can be performed. The arm can be easily moved to the assistant's side for cleaning. Your patient can step in and out of the chair even when the arm and the instrument console are moved to the left side.



TAILORED FOR YOUR SPECIFIC NEEDS

Non-retractable instruments

The well balanced and non-retractable instrument arms are features you will appreciate in your daily work. You can choose the positions of the instruments according to your preferences and working habits.

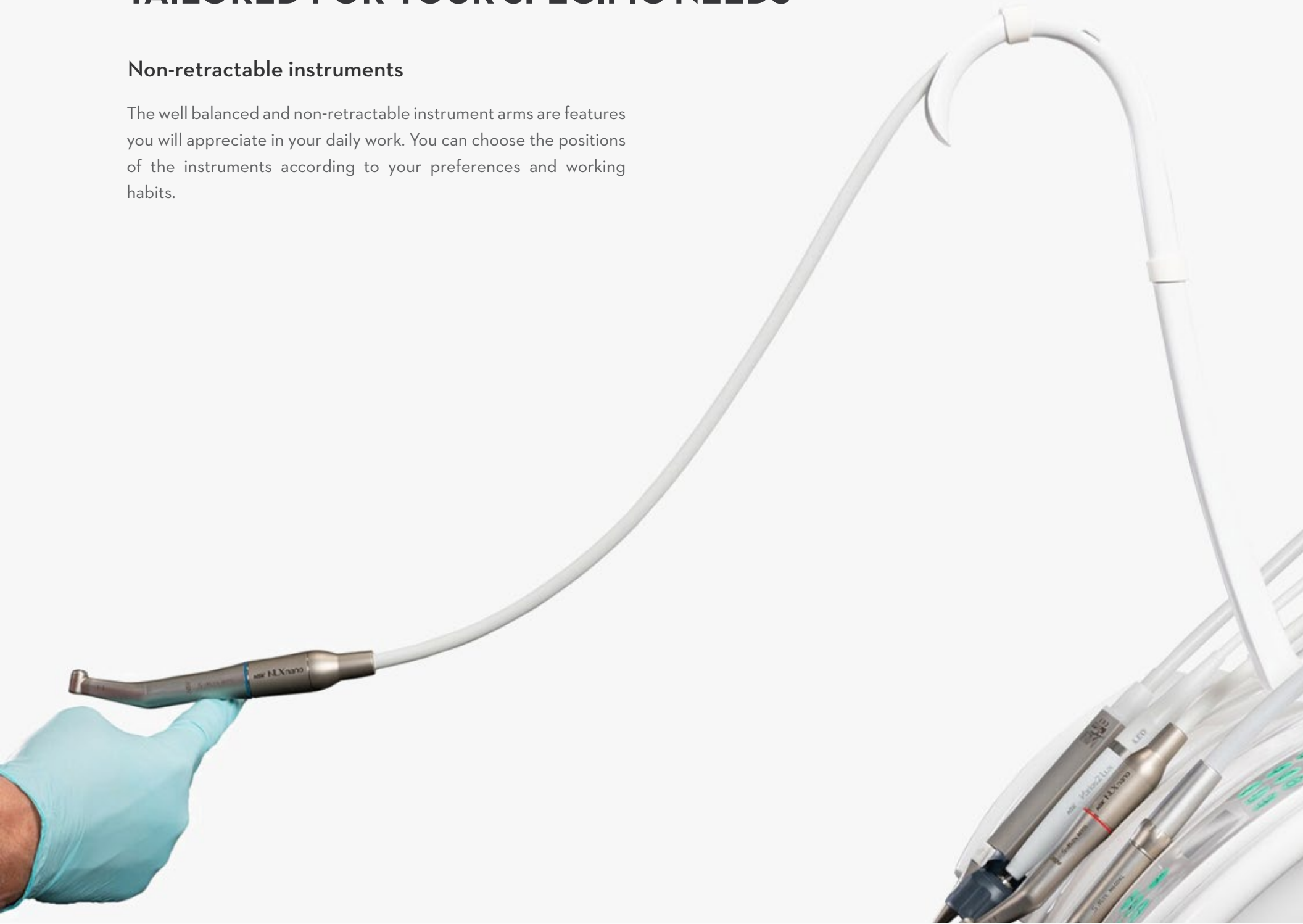

Removable hygiene covers

Both the instrument console and the assistant's console are equipped with a hygienic silicone cover to ensure excellent hygiene.



Customizable instrument bridge

Left-handed? Right-handed? Doesn't matter. Rearrange tools in moments to suit anyone on your team in seconds.



Efficient instrument bridge

The instrument console is compact and can be equipped with up to five instruments to suit your needs.

The touch screen is an optional accessory that can be installed on either the left or right side of instrument bridge.



THE PATIENT CHAIR

A relaxed patient lets you focus fully on the treatment. A thin backrest allows the care team to get close to the patient. This ergonomic NEO Ceiling chair perfectly complements the whole. Different working positions can be individually programmed for multiple users.

The chair has an exceptionally wide range of motion of 450-950 mm, which allows you to work both sitting and standing.

The rotating arm rests allow easy access to the chair. These hygienic arm rests are removable.

A special cushion is available for children.

Two joystick foot controls for manual and automatic movements are located in the chair's base. The chair can also be operated from the instrument bridge and from the assistant's element.



QUALITY TOOLS

As you deserve the best possible tools to perform the most demanding treatments, we have only preselected instruments from well-established manufacturers for you. The choice is yours.

Micromotors

All our electric micromotors have internal spray cooling and light. They are compatible with all ISO Type E contra-angles and handpieces and are made by well-known European and Japanese manufacturers.

When working with any of the listed Neo Ceiling micromotors, you can choose and individually adjust between three speed ranges, making it easy to select exactly the speed you require.



KCL-LED COUPLING

LED COUPLING FOR KAVO MULTIFLEX

NSK, Japan

- Attach NSK micromotor to your existing Kavo MultiFlex system
- Colour temp 6500K and luminance 32000 Lux
- Adjustable water pressure



6- AND 3-WAY SYRINGES

DENTAL SYRINGE

Luzzani Dental, Italy

- Available in angled and straight type
- Stainless steel sleeve

MICROMOTORS



MX2 PLUS
Bien Air Dental, Switzerland

- Motor speed rating min. 100 max. 40 000 rpm
- Motor torque rating 3,5 Ncm
- Weight 79 g

Brushless motor.



MCX LED
Bien Air Dental, Switzerland

- Motor speed rating min. 1000 max. 40 000 rpm
- Motor torque rating 2,5 Ncm
- Weight 76 g

Brushless motor



MC3 LED
Bien Air Dental, Switzerland

- Motor speed rating min. 60 max. 40 000 rpm
- Motor torque rating 2,8 Ncm
- Weight 100 g

With autoclavable detachable sleeve.



NBX LED
NSK, Japan

- Motor speed rating min. 2 000 max. 40 000 rpm
- Motor torque rating 4,0 Ncm
- Weight 83 g
- Length 76 mm including hose connector

Solid titanium outer body.

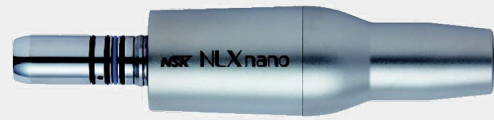

NLX NANO LED
NSK, Japan

- Motor speed rating min. 2 000 max. 40 000 rpm
- Motor torque rating 3,4 Ncm
- Weight 61 g
- Length 68,8 mm including hose connector

Brushless motor, thus no need to change carbons as in conventional micromotor. Complete motor is autoclavable up to 135 °C.

ULTRASONIC SCALERS AND OTHER TOOLS



SATELEC MINI LED
CURING LIGHT
ACTEON, FRANCE

- Power output 1250mw/cm² - 2000mw/cm²
- Curing time is 6 - 12 seconds for 2mm of any composite



SATELEC SP4055
ULTRASONIC SCALER
ACTEON, FRANCE

- Frequency range 28-36 kHz
- Max. power output 9 W
- Delivery includes tips 1, 10P and 10X, protection tip and universal wrench.



SATELEC NEWTRON LED
ULTRASONIC SCALER
ACTEON, FRANCE

- Frequency range 28-36 kHz,
- max. power output 12 W
- Delivery includes tips 1, 10P and 10X, sterilisation box and one torque wrench



MECTRON STARLIGHT +
CURING LIGHT
MECTRON, ITALIA

- Power output > 1400 mW/cm²
- Curing Time 10-20 seconds for modern composites



PIEZON NO PAIN LED
ULTRASONIC SCALER
EMS, SWITZERLAND

- Frequency range 24-32 kHz
- max. power output 8 W
- Delivery includes tips A, P and PS, autoclavable sterilisation box and 3 torque wrench keys

Dynamic power-response feature that constantly regulates the ultrasonic power to the applied load.

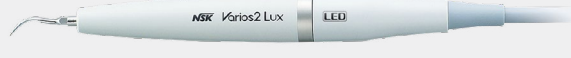

VARIOS 170 LED
ULTRASONIC SCALER
NSK, JAPAN

- Frequency range 28-32 kHz,
- max. power output 11 W
- Delivery includes tips G4, G8 and G16, autoclavable sterilisation box and 3 torque wrench keys

The iPiezo engine assures stable output by automatically adjusting to the optimum frequency depending on the loading of the tip.

COLORS

Choose your favourite

Seamless, easy-to-clean ComFORT and XtraSOFT upholsteries are available in many attractive colours. This material has a smooth and shiny surface with a skin-friendly coating. It is waterproof and can be disinfected.

imitation leather from the FIMET -collection complies with the relevant regulations of the EC directive 93/42/EWG on medical devices, and it is biocompatible according to EN ISO 10993.



UltraLUX upholstery features a classic natural grain with a subtle luminescence that provides a hint of luxury and refinement. Memory foam adapts fully to the patient's body shape and is pleasant and relaxing.

The specifications and colours in this leaflet may vary from the actual product and are subject to change without prior notice. Ask your local FIMET distributor for colour samples.

Ruby red
818



Orchid
1900

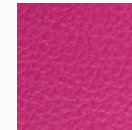

Purple red
802

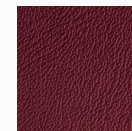

Turquoise
263

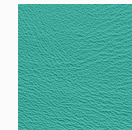

Emerald green
824



Royal blue
268



Night blue
225

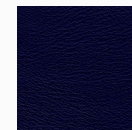

Anthracite
316

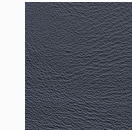

Chocolate brown
815

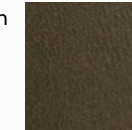

Black
260

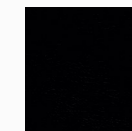

Ocean blue
819



Metallic blue
2691



Forest green
4304

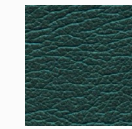

Graphite v2
5806



STOOLS

Sit well and choose one of the stool options.



Classic



Dental



Pony



PATIENT LIGHT

In order to achieve the best results under health and safety conditions, dentists need to operate in a clear view environment. The light must be able to reduce the shadow effect of instruments and natural barriers to a minimum. We have chosen professional lighting system for you with advanced LED technology from leading specialised manufacturer.

POLARIS COMPOSAFE

Polaris Composafe features the COMPOSAFE mode, which eliminates wavelengths that cause premature photopolymerization, making it easier to work with composites and resins without the risk of pre-polymerization.

This gives the dentist more working time with the composite material.

The POLARIS COMPOSAFE lamp is equipped with a proximity sensor through which it is possible to turn the lamp on and off and switch from one mode to another.



GCOMM - POLARIS



Color temperature can be adjusted between 4 200 and 6 000 K. This allows the color temperature to be adjusted in order to improve the contrast on soft tissues, increasing the visibility and the resolution.

It is possible to adjust illuminance between 8 000 to 50 000 Lux.

An easily cleanable front cover keeps the reflectors protected from dust and damages.

An optional mirror and anti-polymerization filter can be easily added to your Polaris light.

FARO - EVA



Lighting level can be adjusted from 3 000 to 50 000 Lux.

Due to the high CRI value (Color Rendering Index) of 97 the quality of the colors and the details in the mouth of the patient are fully realistic and respected.

The optional FARO SCREEN protection cover with a patient mirror can be mounted on the light also afterwards.

PATIENT CHAIR	Standard	Optional
2 joysticks for manual and automatic movements	●	
Minimum chair height 45 cm, maximum 95 cm	●	
4 memory positions including 'last-position'	●	
Length adjustable back rest, adjustable seat angle	●	
Double articulated head rest	●	
Maximum allowed patient weight 180 kg	●	
Set of arm rests that swivel to side, removable	●	
Seamless ComFORT upholstery	●	
Seamless XtraSOFT upholstery		●
UltraLUX memory foam upholstery		●
Children's cushion		●

INSTRUMENTS	Standard	Optional
3F syringe, stainless steel, straight or angled, Luzzani		●
6F syringe, stainless steel, straight or angled, Luzzani		●
Turbine tubing with light		●
Electric micromotor with light - KaVo, NSK, BienAir		●
Electric micromotor with light, brushless, NSK NLX nano LED		●
Electric micromotor with light, brushless, BienAir MX2 or MCX		●
Ultrasonic instrument, Acteon SUPRASSON		●
Ultrasonic instrument with light - NSK, Acteon, EMS		●
Curing light, Acteon miniLED, Spring Health CURE TC-24		●
Led coupling, connect NSK micromotor to KaVo MultiFlex		●
NSK Varios 170, EMS		●

ASSISTANT'S ELEMENT / SUCTION ARM	Standard	Optional
High- and low-volume suction tubings	●	
Chair-mounted suction arm, height adjustable		●
3F syringe, stainless steel, angled, Luzzani MINlight		●
Autoselective suction valve	●	
Curing light, Acteon miniLED		●
Curing light, Spring Health CURE TC-24		●
Silicon hygiene cover	●	
2 handles	●	
User interface and display for assistant	●	
Standard and mini suction arms	●	

STOOLS	Standard	Optional
DENTAL with adjustable seat angle		●
CLASSIC with round seat		●
PONY saddle stool		●

DENTIST'S ELEMENT	Standard	Optional
Instrument console for 5 instruments	●	
User interface and display for dentist	●	
Additional 5" touch panel		●
Spray adjustment, 1 or 4 knobs		●
Tray holder for 1 normal tray		●
Tray holder for 2 normal trays		●
Wireless multifunction foot control horizontal or vertical use	●	
Silicon hygiene cover	●	
2 handles	●	
Interchangeable instruments - Quick connectors		●
Hose release from dorio, Continental		●

WATER UNIT	Standard	Optional
Unit top cover and cuspidor made of natural acrylic stone	●	
Amalgam separator, Metasys MST1 for dry suction		●
Separator, Metasys ECO for dry suction		●
Preparation for wet-suction system		●
Semi-automatic flushing system for instruments		●
Continuous treatment of water lines WEK, DVGW approved		●
Continuous treatment of water lines WEK Light		●
Water bottle		●
Water heater for instruments and cup filler		●
Metasys H1, continuous suction cleaning		●

OPERATING LIGHTS	Standard	Optional
Polaris LED		●
Polaris LED with on/off sensor		●
Mirror and anti-polymerisation filter for Polaris		●
Faro EVA LED		●
Polaris Composafe		●

MULTIMEDIA	Standard	Optional
22" medical grade display with mounting arm		●
External USB interface		●
Intraoral camera		●
External USB2 and USB3 interface		●

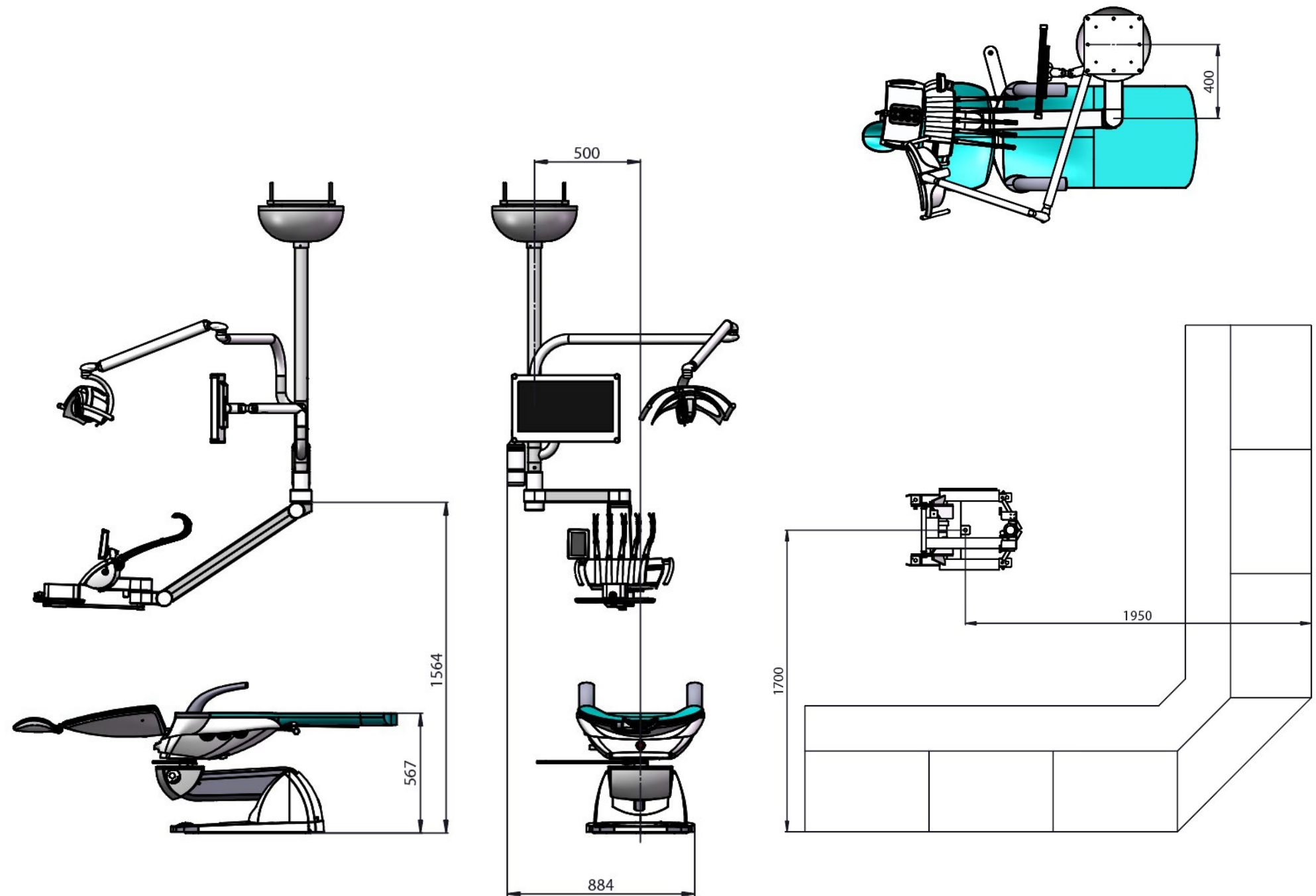

NEO *Ceiling*

The Fimet Neo Ceiling Dental Unit is more than a dental chair—
it's the foundation of a smarter, more efficient practice.

For more information, visit www.fimet.fi or contact an authorized
dealer.

FIMET

Fimet Oy

Teollisuustie 6

FI-07230 Askola

Finland

+358 19 521 6600

fimet@fimet.fi

www.fimet.fi